

SHARP

Graphing Calculator **EL-9450/9400** OPERATION GUIDE



Introduction

The EL-9450/9400 was developed to meet the needs of an expanding education market and is based on three concepts: easy to teach, easy to learn and easy to use. The EL-9450/9400 has been designed with simplified operations and time-saving features, allowing teachers to concentrate on actual teaching.

This manual was designed to introduce teachers to the unique features of the EL-9450/9400 using detailed operation examples.

Built-in slide shows
Educational tools
(OHP/PC-link/Data collection)

Easy to Teach

For Education

Easy to Learn

Shift/Change function
Equation editor
Split display

Easy to Use

Large display
Rapid graph
Rapid window
Rapid zoom

Contents

Sales points	P 1	System options	
Basic operation	P 2	PC-link system	P 14
Equation editor	P 4	Set to set communication	P 15
Features		OHP system	P 16
Shift	P 5	Menu tree 1~6	P 17
Change	P 6	Specifications	P 23
Slide show	P 7		
Slide show selections	P 8		
Graphing procedure	P 10		
Rapid graph	P 11		
Rapid window	P 12		
Rapid zoom	P 13		

Sales points

① Large 96 x 64-dot display

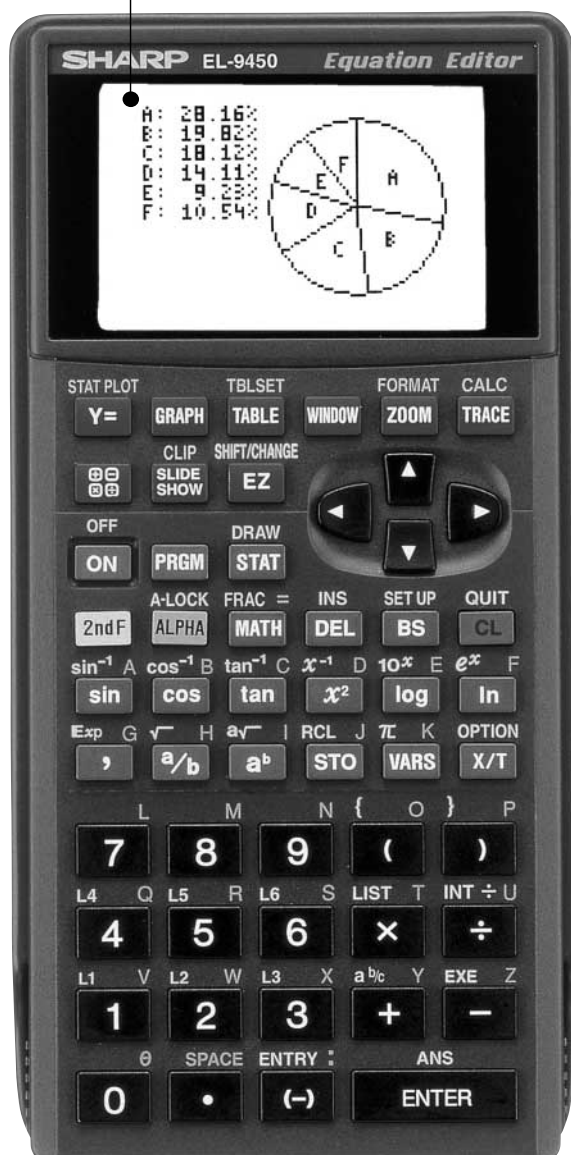

② Graph Shift/Change shows how "changing" the graph affects the equation

③ Slide Shows reduce class preparation time

④ Equation Editor shows equations just as in textbooks

⑤ Rapid graph/Rapid window simplify graphing procedures

⑥ Rapid zoom allows easy adjustment of window size

Basic operation

Power ON/OFF

ON Power on

2nd F **OFF ON** Power off

CL Erase equations and remove error displays

2nd F **QUIT CL** Cancel of previous function (Escape)

Function keys

- Y=** Use to enter equations
- GRAPH** Use to draw graphs
- TABLE** Use to view table of function value
- WINDOW** Use to set size of viewing window
- ZOOM** Use to adjust the viewing range
- TRACE** Use to trace graphs
-  Use to enter calculation mode
- SLIDE SHOW** Use to enter slide show mode
- EZ** Use to operate Rapid Graph/Rapid Window and Rapid Zoom functions

Names of parts

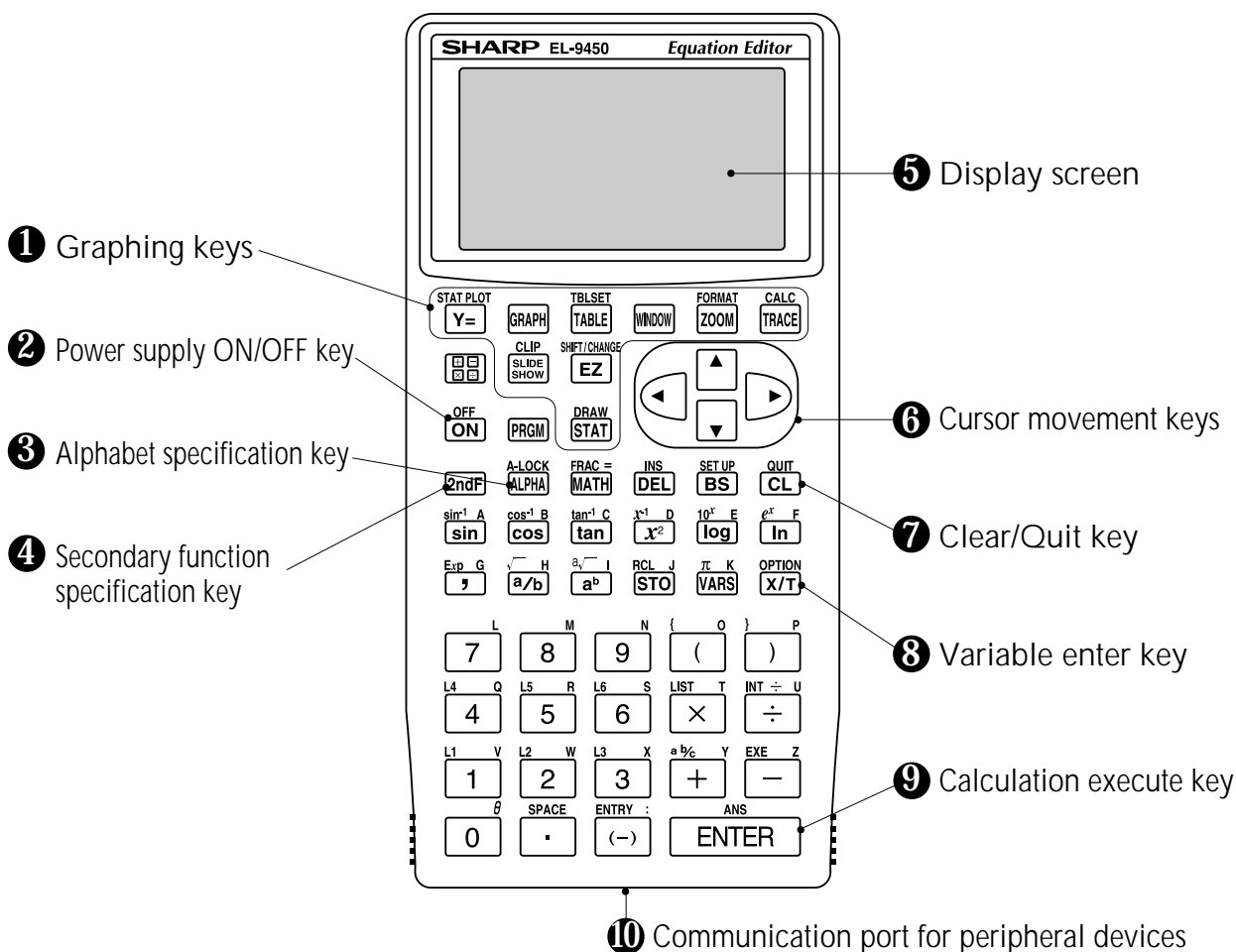

Basic operation

Guide to key use

Press **2nd F** to use secondary functions (in yellow).

Press **ALPHA** to use the alphabet keys (in blue).

Example: $\sin^{-1} A$
sin

To select "sin": **sin**

To select " \sin^{-1} ": **2nd F** **sin**

To select A: **ALPHA** **sin**

SET UP menu

Press **2nd F** **SETUP** **A**.

- Contents displayed on the right side of the screen are the current settings.



[There may be differences in the results of calculations and graph plotting depending on the SET UP settings.]

Adjusting screen contrast

- The contrast adjust screen will appear when pressing

2nd F **OPTION**.



Press **-** to lighten contrast.

Press **+** to darken contrast.

Reset function

1) When trouble occurs

Press **2nd F** **OPTION** **E** to enter the reset mode.



- Use this function (**1** or **2**) to return all settings to the default value or to delete all data.

2) All RESET operation

- If trouble still occurs, proceed as follows:
 1. Press the RESET switch on the back.
 2. Press **ON**.
 - Returns to the initial display.

CAUTION

Do not press **CL** in step 2. It will delete all data stored in the calculator.





Equation editor

The equation editor allows equations to be viewed just as they are written in textbooks. This aids student comprehension and allows mistakes to be found quickly.

Example

Input the equation and see how it can be easily viewed with the equation editor.

$$\int_0^{\frac{1}{2}} \frac{x}{\sqrt{1-x^2}} dx$$

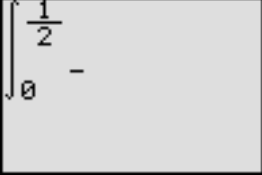
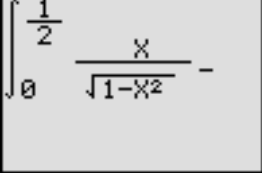
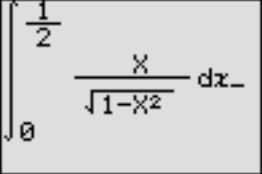
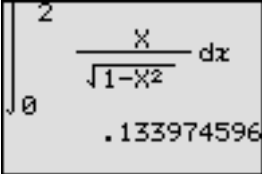

	<u>Key Operation</u>	<u>Display</u>	<u>Notes</u>
1	 		Clear the display.
2	MATH ENTER ▼ ▼ ▼ ▼ ▼ (or MATH A 6)		Select CALC and ∫ (Integral function)
3	ENTER 0 ►► 1 a/b 2 ►►►		Enter the range of the integral.
4	X/T a/b 2ndF √ 1 - X/T X ² ►►►		Enter $\frac{x}{\sqrt{1-x^2}}$
5	MATH ENTER ▼ ▼ ▼ ▼ ▼ ▼ ENTER (or MATH A 0 7)		Complete equation input.
6	ENTER		Calculate the expression. [The blinking mark in the upper right side of the display indicates the expression is being calculated.]

Shift (Change the location of graphs)

Graph shift function helps students grasp the relationship between an equation and its graph. Shift the graph's location without changing its shape, and the change is immediately reflected in the equation on the right side of the display.

Example

When the graph of $y = x^2$ is shifted downward, how does this affect the equation?

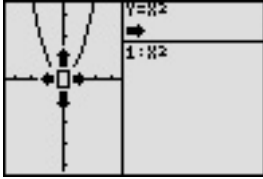
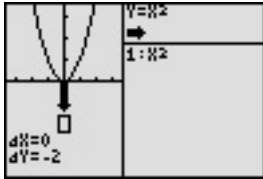
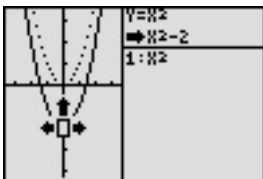



<i>Key Operation</i>	<i>Display</i>	<i>Notes</i>
1 2nd F SHIFT/CHANGE		Enter SHIFT/CHANGE mode. [If SHIFT is not already highlighted press ▲ .]
2 ENTER		Select shift. Cursor moves to the equation menu.
3 ENTER		Select the equation: $y = x^2$ and draw the graph.
4 ▼ ▼		Select the location of the shift: move cursor down twice.
5 ENTER		View the result of the shift. $\left[\begin{array}{l} y = x^2 \\ \downarrow \\ y = x^2 - 2 \end{array} \right]$

Change (Change the shape of the graphs) _____

Graph change function helps students grasp the relationship between an equation and its graph. Change the shape of the graph, and the change is immediately reflected in the equation on the right side of the display.

Example

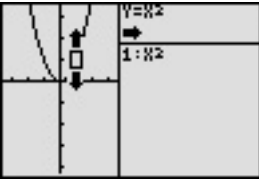
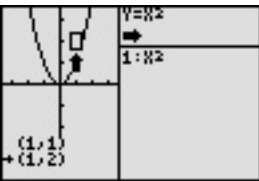
When the graph of $y = x^2$ is changed, how does it affect the equation?

	<u>Key Operation</u>	<u>Display</u>	<u>Notes</u>
1	<div style="border: 1px solid black; padding: 2px; display: inline-block;">2nd F</div> <div style="border: 1px solid black; padding: 2px; display: inline-block; margin-left: 10px;">SHIFT/CHANGE</div> <div style="border: 1px solid black; padding: 2px; display: inline-block; margin-left: 10px;">▼</div>		Enter SHIFT/CHANGE mode and specified (B CHANGE).
2	<div style="border: 1px solid black; padding: 2px; display: inline-block;">ENTER</div>		Select change. Cursor will move to the equation menu.
3	<div style="border: 1px solid black; padding: 2px; display: inline-block;">ENTER</div>		Select the equation: $y = x^2$ and draw the graph.
4	<div style="border: 1px solid black; padding: 2px; display: inline-block;">▲</div>		Select the location of the change: increase the value of y-coordinates.
5	<div style="border: 1px solid black; padding: 2px; display: inline-block;">ENTER</div>		View the result of the change.

$$\left[\begin{array}{c} y = x^2 \\ \downarrow \\ y = 2x^2 \end{array} \right]$$

Slide show

Slide show assists with teacher preparation. By selecting from the built-in options or creating your own series of slides, you can demonstrate lessons with minimum preparation time.

Example

Use the built-in slide show of $y = x^2$ to show how the coordinates change as you move along the graph.

	<u>Key Operation</u>	<u>Display</u>	<u>Notes</u>
1	SLIDE SHOW		Specified SLIDE SHOW mode.
2	ENTER		Select the built-in menu.
3	ENTER		Select $y = x^2$ and the first slide appears.
4			<p>Begin the slide show by pressing the cursor key.</p> <p>Moving between the values you can follow the changes in the graph's coordinates, making the nature of the graph easier to understand.</p>

* View the selection of built-in slide shows on the following pages.

Built-in slide show selections _____

1) $Y=X^2$

2) $Y=AX+B$

3) $Y=\sqrt{X}$

4) $Y=1/X$

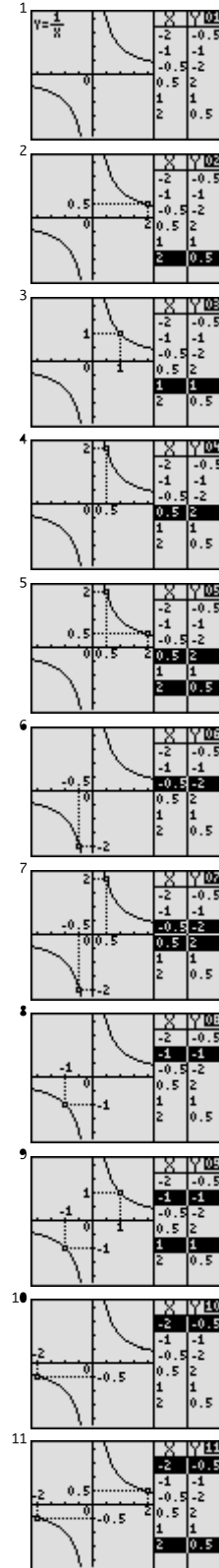
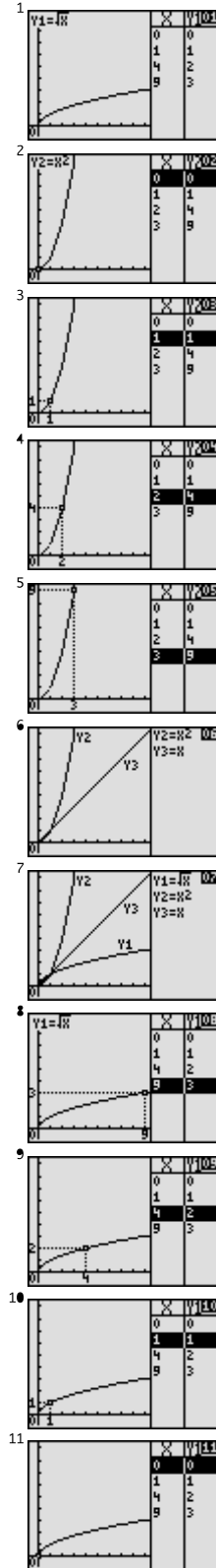
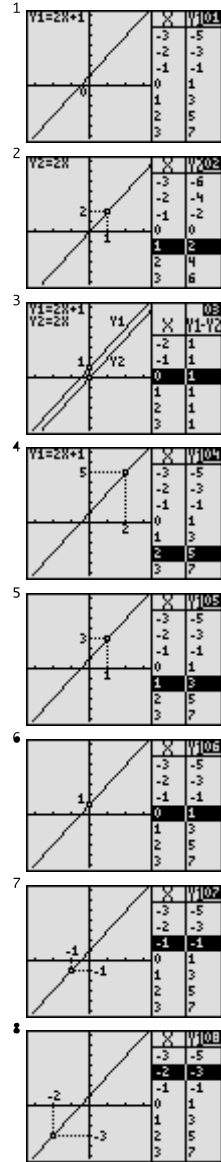
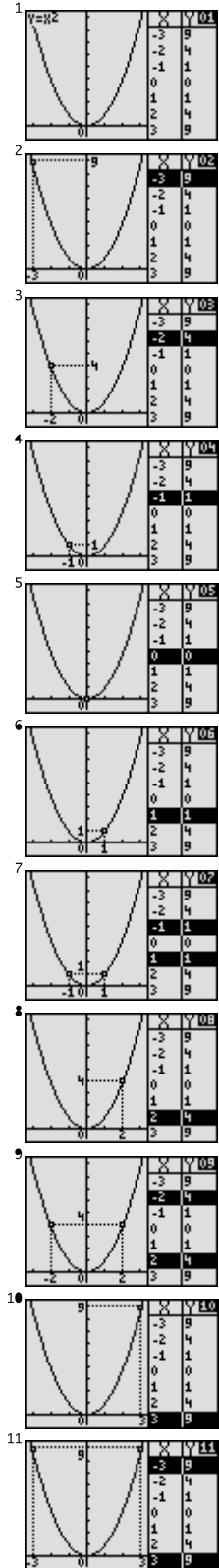

Built-in slide show selections _____

5) $Y=\sin X$

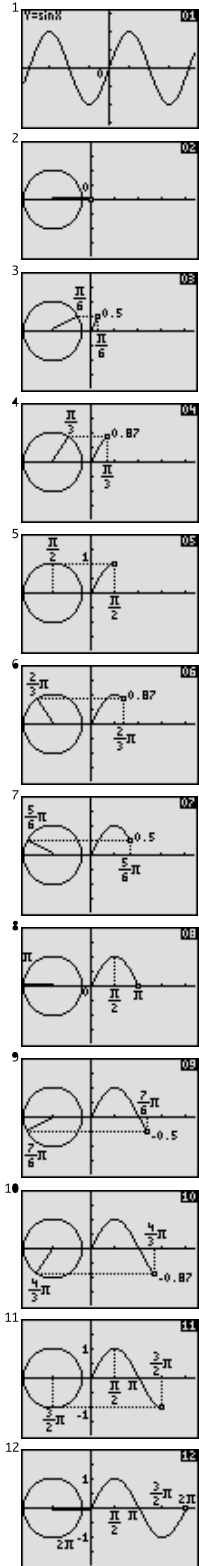

6) $Y=\tan X$

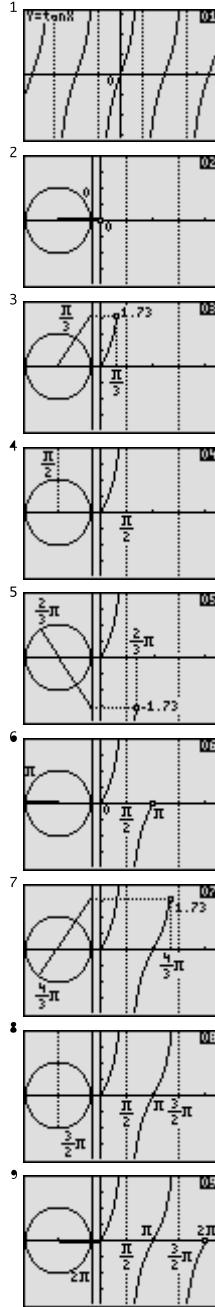

7) $Y=\cos^{-1} X$

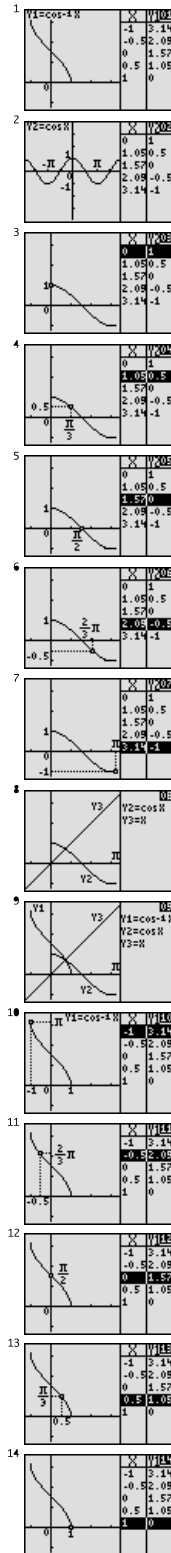

8) $Y=\ln X$

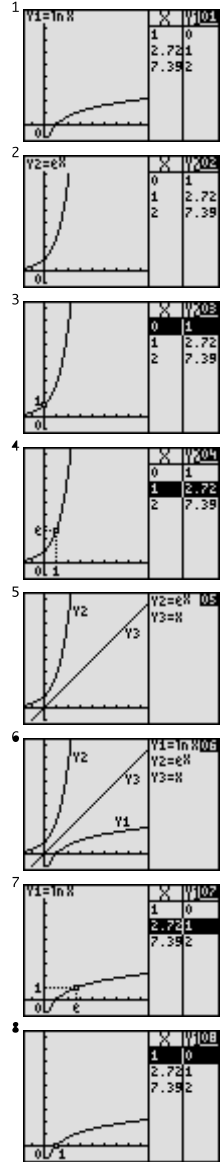

Graphing Procedures

The EL-9450/9400 has three unique functions that simplify graphing procedures: Rapid Graph, Rapid Window and Rapid Zoom. Of course, the EL-9450/9400 supports conventional graphing procedures as well.

Graphing Procedure

Following outlines graphing procedures and indicates the steps where Sharp's unique functions can be used to simplify operations. These functions are introduced on the following pages.

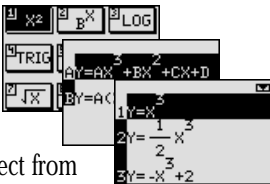
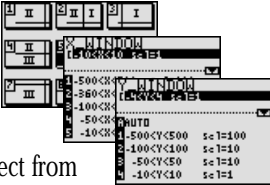
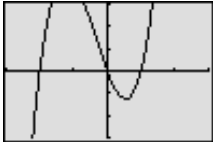
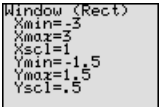
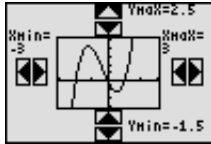

<p><u>Step 1</u></p> <p>Input equation</p>	<p>Manual Input</p> <p>Y=</p> <p>x^2 $-$ 2 x</p>	<p>Rapid Graph</p> <p>EZ</p>  <p>Simply select from built-in menu to modify desired type of equation.</p>
<p><u>Step 2</u></p> <p>Set X, Y range</p> <p>Xmin = Xmax = Xscl = Ymin = Ymax = Yscl =</p>	<p>Manual Input</p> <p>WINDOW</p> <p>(-) 3 ENTER 3 ENTER</p> <p>1 ENTER (-) 1 . 5 ENTER</p> <p>1 . 5 ENTER . 5 ENTER</p>	<p>Rapid Window</p> <p>EZ</p>  <p>Simply select from built-in menu to set window size.</p>
<p><u>Step 3</u></p> <p>Draw graph</p>	<p>GRAPH</p>  <p>Press Graph button to draw graph.</p>	
<p><u>Step 4</u></p> <p>Adjust viewing window</p>	<p>Manual Input</p> <p>WINDOW</p>  <p>Amending range size</p> <p>GRAPH</p> <p>Go back to Step 2 to readjust window size.</p>	<p>Rapid Zoom</p> <p>EZ</p>  <p>Use arrows to adjust window size while viewing graph.</p>

Rapid graph

Graphing has never been easier. With its full range of preset equations, rapid graph simplifies equation input. Use in conjunction with the rapid window function or with any graph created.

Example

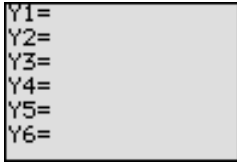
Draw the graph for $y = 2\sin(-2x + \pi) + 2$ using the rapid graph function.

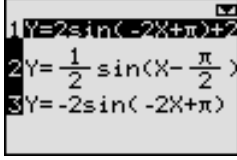
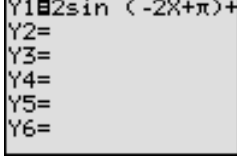
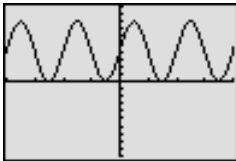

Key Operation	Display	Notes
1 $Y=$		Enter the equation entry mode.
2 EZ		Enter Rapid Graph mode and view the equation-type menu.
3 ∇ $ENTER$		Select the type of equation: Trigonometric, and view the equation format menu.
4 $ENTER$		Select the sin equation format and view the sin equation style.
5 $ENTER$		Select the second equation style and input. If necessary, make changes to the coefficients.
6 $GRAPH$		Draw the graph. (Note: Previous range values may affect the viewing window. To reset range values, use Rapid Window.)

Rapid window

Rapid window simplifies setting window size with a range of preset values. Use in conjunction with the rapid graph function or with any graph created.

Example

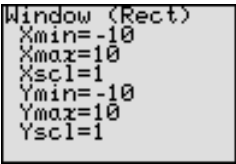
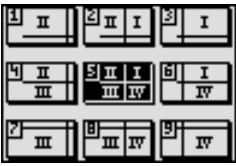
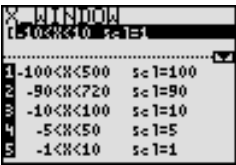
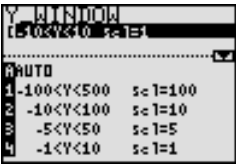
After using Rapid Graph to draw the graph of $y = 2\sin(-2x + \pi) + 2$ (refer p. 11), set the viewing window using the rapid window function.

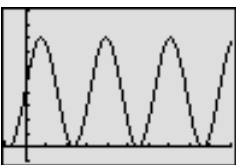
Key Operation	Display	Notes
1 WINDOW		Enter viewing window setup mode.
2 EZ		Enter Rapid Window mode.
3 ▼ ► ENTER		Select the No. 3 style and view the X-range menu.
4 ▼ ENTER (Five times) (or 5 ENTER)		Select X-range No. 4: $(-1 < X < 10 \quad scl=1)$, and view the Y-range menu.
5 ▼ (Six times) (or 5)		Move the cursor to No. 5: $(-0.5 < Y < 5 \quad scl=0.5)$
7 ENTER		Select the Y-range and draw the graph.

Rapid zoom

Rapid zoom offers one-touch adjustment of window size while viewing the graph. No more guessing or wasting class time to find optimal values for window size.

Example

Adjust the viewing window for $y = x^3 + x^2 - 2x$ to show the entire graph.

1

Key Operation

Y= X/T a^b 3 ► +
 X/T x^2 - 2 X/T
 WINDOW (-) 3 ENTER 3
 ENTER 1 ENTER
 (-) 1 · 5 ENTER 1 · 5
 ENTER · 5 ENTER GRAPH

Display

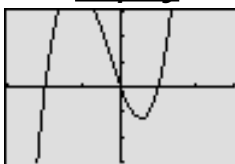

Notes

Create the graph $y = x^3 + x^2 - 2x$ using the following conditions:
 X-range: xmin = -3
 xmax = 3
 xscl = 1
 Y-range: ymin = -1.5
 ymax = 1.5
 yscl = 0.5

2

EZ

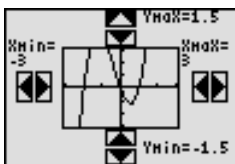

Enter Rapid Zoom mode.

3

▼ ENTER

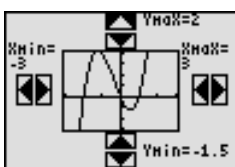

Change X-range from Ymax = 1.5 to Ymax=2. Draw the graph.

4

ENTER

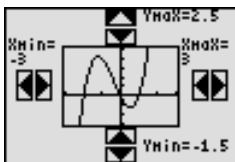

Repeat: Change Y-range from Ymax = 2 to Ymax=2.5. Draw the graph

5

GRAPH

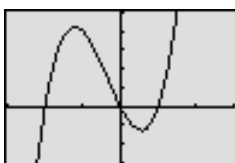

View display (adjusted).

PC-LINK

Connect the EL-9450/9400 with a PC or Macintosh computer to expand the possibilities of data exchange using PC-Link software.

CE-LK1P (PC-link system)

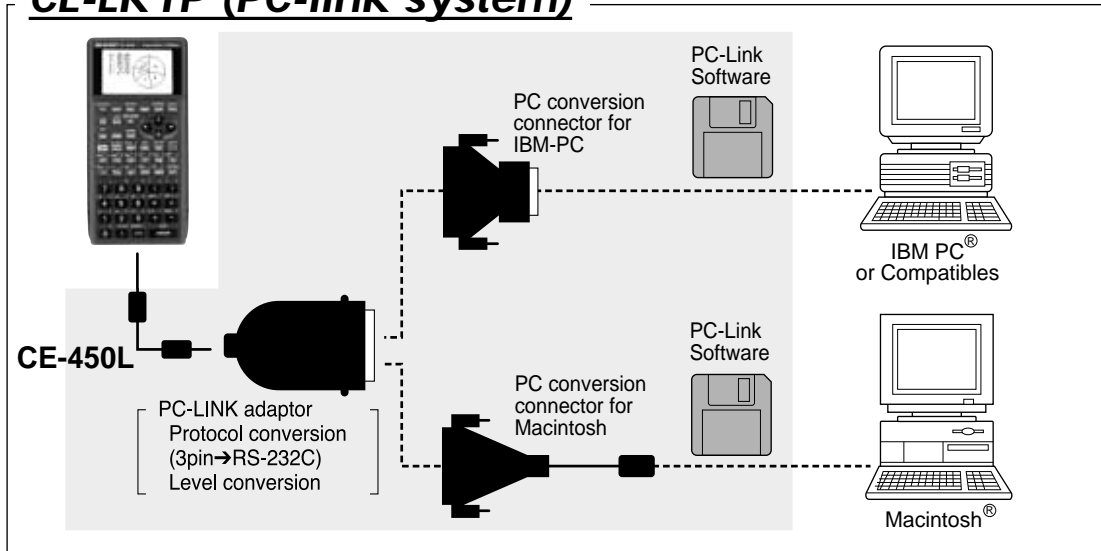

What is PC LINK?

- Creates and edits EL-9450/9400 programs on a PC.
- Receives and saves programs and various data from EL-9450/9400.
- Makes a backup of all the contents of EL-9450/9400.
- Sends programs and various data to EL-9450/9400.
- Loads image data of EL-9450/9400.
- Converts programs and various data files into a Text File. Converts program text files into a Program File.
- Prints out programs and various data files.

Procedure

- 1 Turn off the EL-9450/9400.
- 2 Connect the EL-9450/9400 to the PC by using the CE-450L, PC-Link adaptor and PC connector (see above diagram).
- 3 Make sure that the RS-232C (serial port) is connected to the PC. Use of the connector is determined by the shape of the PC serial port (see below chart).
- 4 Open PC-Link Software.
- 5 Switch on EL-9450/9400.
* It is essential to use the same port for both the PC and the PC-Link Software.
- 6 Operate according to the instructions on the screen.

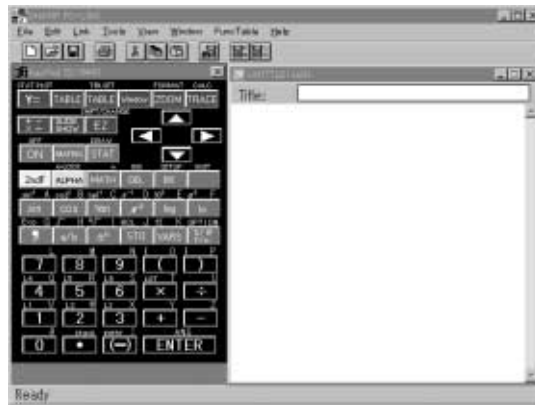

Shape of PC serial port	Connecting procedure
25 pin (male)	Connect the other side (25-pin side) of PC LINK adaptor to the serial port for the PC.
9 pin (male)	Connect the other side (25-pin side) of PC LINK adaptor to the 25-pin terminal of a converting adaptor. Also connect the other side (9-pin side) of the converting adaptor to the serial port for the PC.
8 pin (female)	For Macintosh

Set to set communication

Transfer data between two EL-9450/9400 calculators using the communication cable (CE-450L).

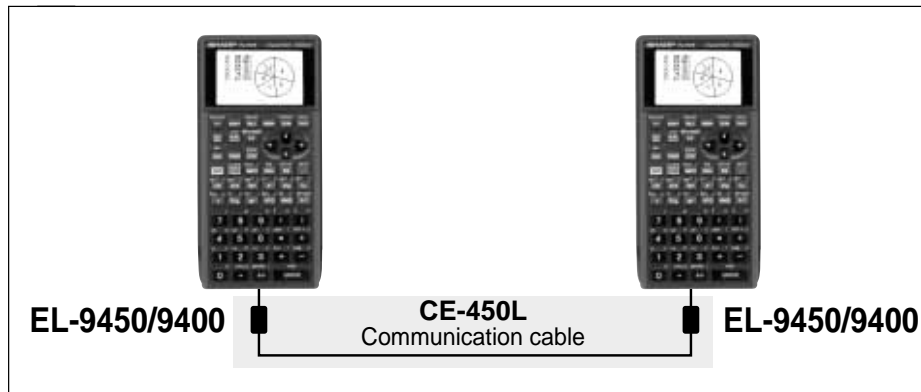

Communication Procedure

1 Plug the cable into both calculators.

2 Turn power on.

3 Receiver

2nd F OPTION



(or D)



Specified LINK.

4 ENTER

ENTER

(or 2)

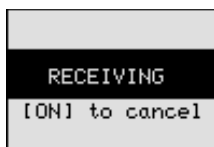

Select LINK/RECEIVE.

5 Sender

2nd F OPTION



(or D)



Specified LINK.

6 ENTER

(or 1)



Select LINK/SEND.

7 ENTER

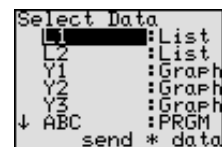

Select SEND/ALL.

[List of sendable data will appear on screen.]

8 ENTER



ENTER

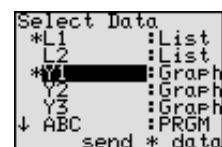

Select 'L1', 'Y1'

[* mark desired data to be sent.]

9 2nd F EXE



Execute Sending function.

List of the SEND menu

A SELECT Sends files individually as described below.
1 ALL Selects and displays all files.
2 List Selects and displays all list files.
3 GraphEq Selects and displays all graph equations.
4 Program Selects and displays all program files.
5 G_Data Selects and displays all graph data files.
6 L_Data Selects and displays all list data files.
7 Picture Selects and displays all picture data files.
8 A-Z, Ø Selects and displays all fixed memory of A to Z, and Ø
B BACKUP Menu to send all file data. Use this feature to send the entire content.

OHP System

Use the EL-9450/9400 OHP system with the overhead projector to make classroom presentations convenient for the whole class to see.

EL-945T/94T (OHP system)

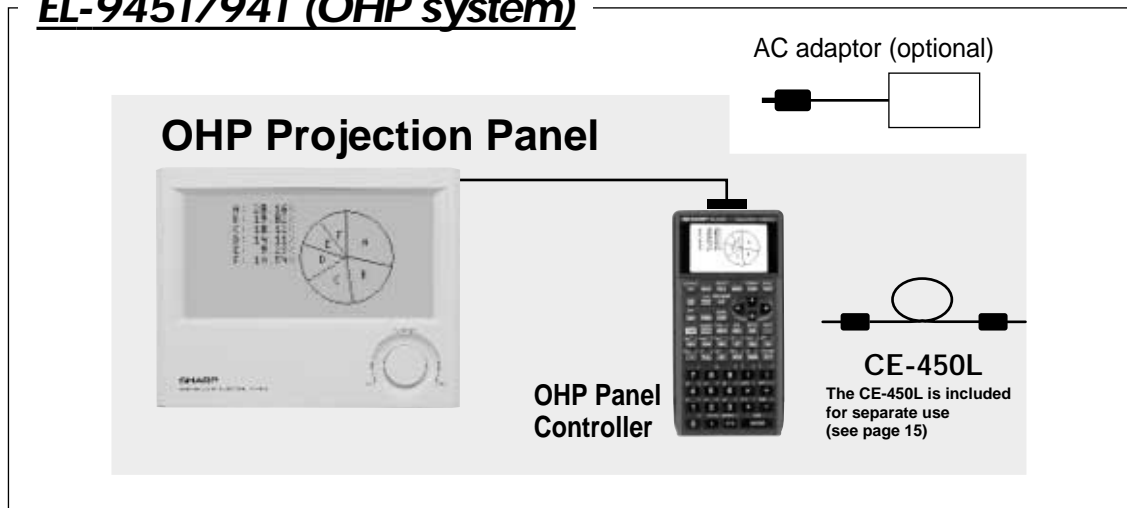

Procedure

1 Switch off the OHP Panel Controller.

2 Plug the cable connector of the OHP Projection Panel straight into the connection terminal of the OHP Panel Controller.

(The optional AC adaptor is recommended for extended use of the OHP Projection Panel.)

3 Switch on the OHP Panel Controller.

4 Operating the OHP Panel Controller.

The OHP Projection Panel display is synchronized with the display of the OHP Panel Controller. Place the OHP Projection Panel on top of the overhead projector to project images onto the screen.

5 Turn on the power to the overhead projector.

Menu tree 1

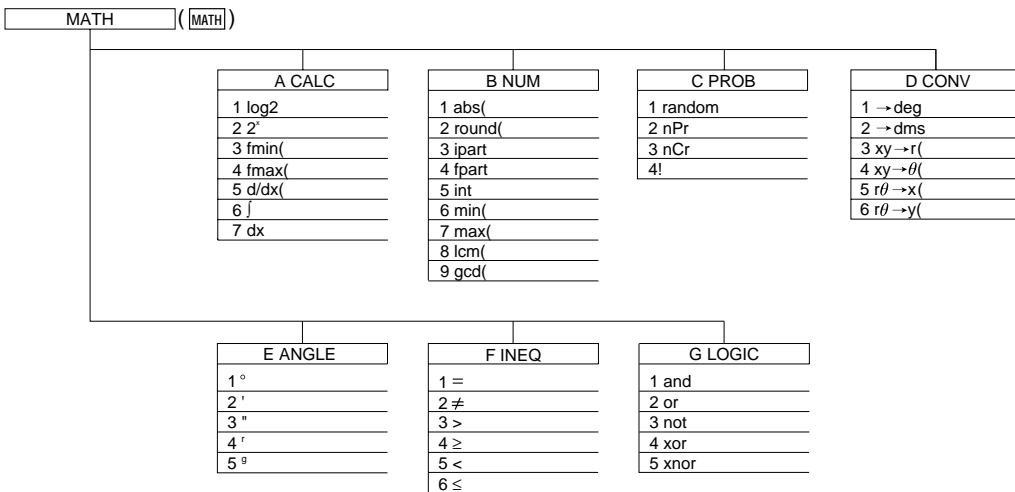
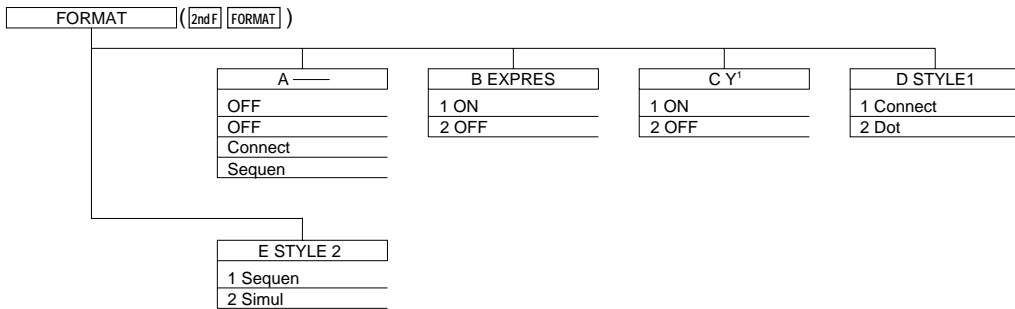
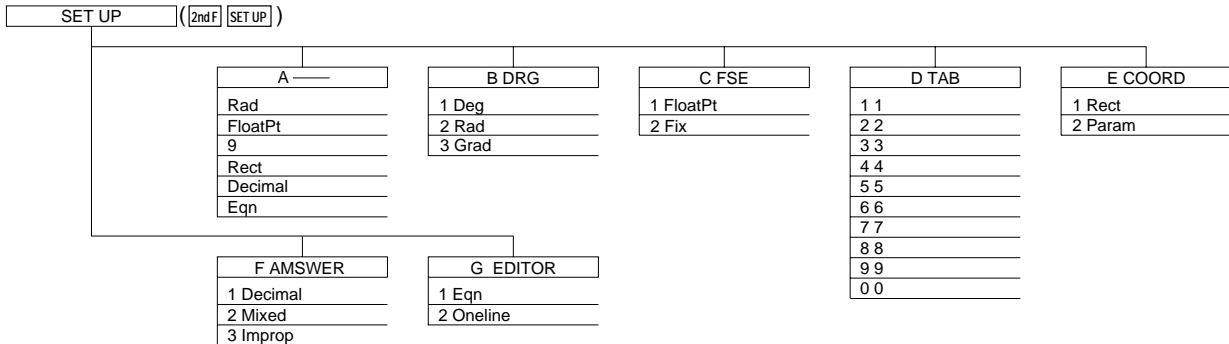

Menu tree 2

When coordinate system is Rect

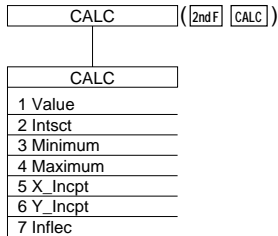

When coordinate system is Param

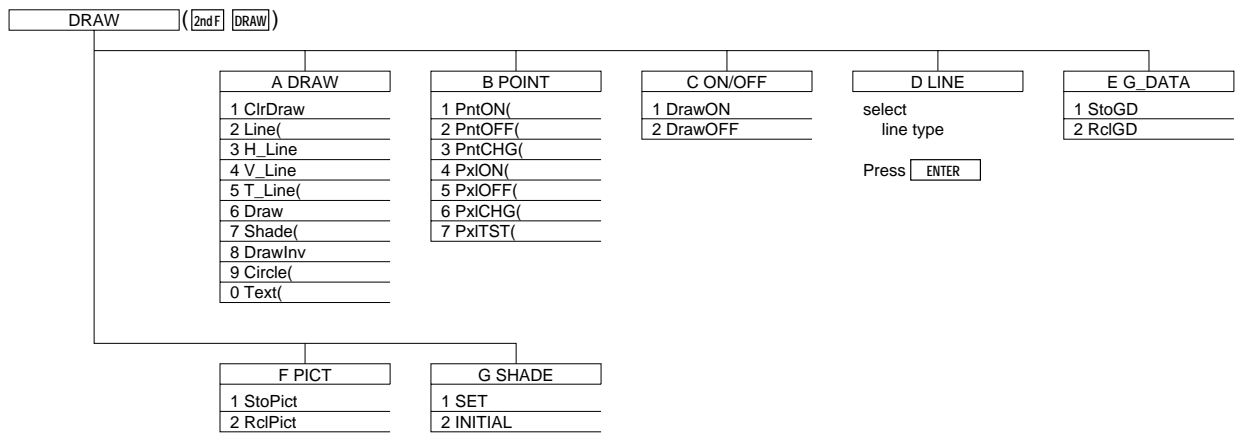
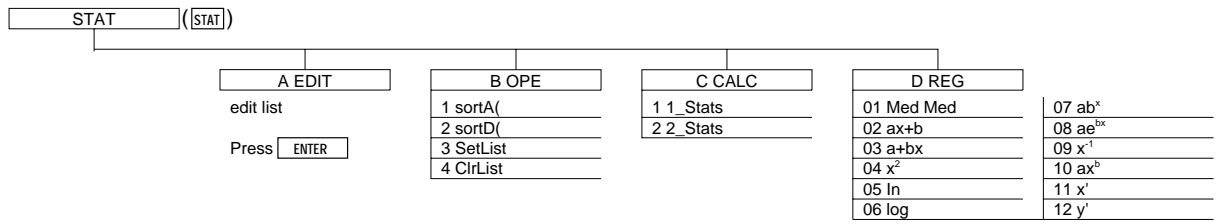
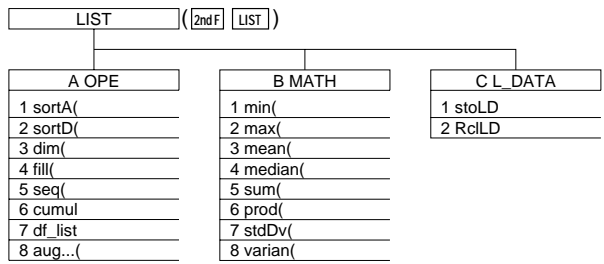
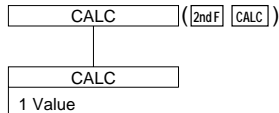

Menu tree 3

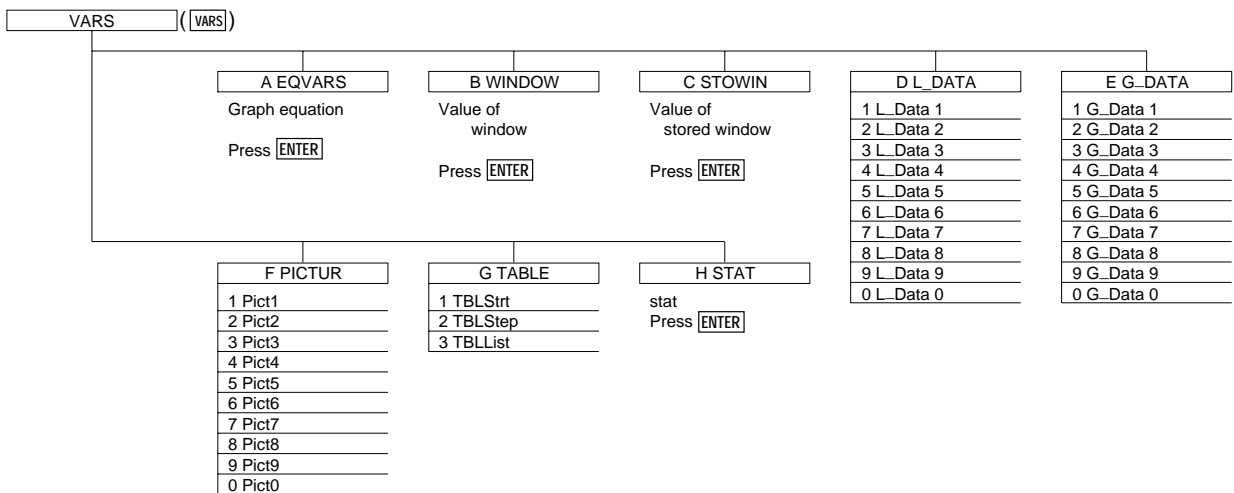
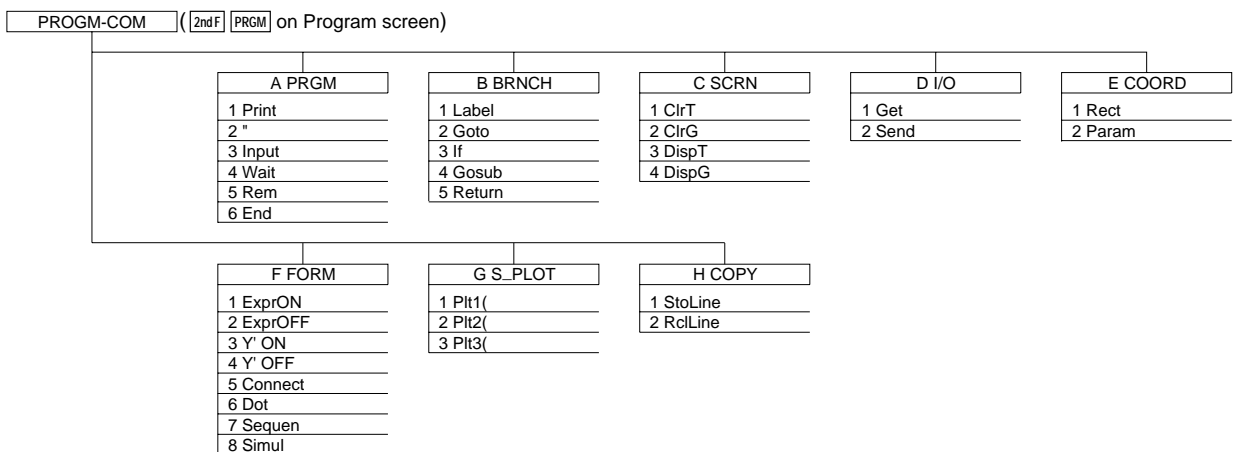
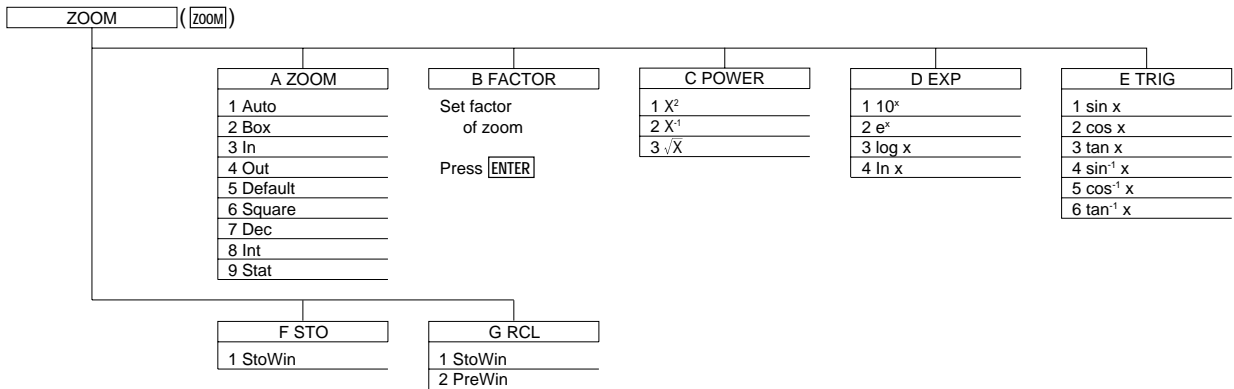

Menu tree 4

EQ VAR (VAR) (A)

A XY		B XYT	
1 Y1		01 X1T	07 X4T
2 Y2		02 Y1T	08 Y4T
3 Y3		03 X2T	09 X5T
4 Y4		04 Y2T	10 Y5T
5 Y5		05 X3T	11 X6T
6 Y6		06 Y3T	12 Y6T
7 Y7			
8 Y8			
9 Y9			
0 Y0			

WIN VAR (VAR) (B)

A XY		B T	
1 Xmin		1 Tmin	
2 Xmax		2 Tmax	
3 Xscl		3 Tstep	
4 Ymin			
5 Ymax			
6 Yscl			
7 X_Fact			
8 Y_Fact			

ZOOM VAR (VAR) (C)

A STOXY		B STOT	
1 Zm_Xmin		1 Zm_Tmin	
2 Zm_Xmax		2 Zm_Tmax	
3 Zm_Xscl		3 Zm_Tstp	
4 Zm_Ymin			
5 Zm_Ymax			
6 Zm_Yscl			

STAT VAR (VAR) (H)

A XY		B REGEQN		C POINTS	
01 n	09 $\sum xy$	1 RegEqn	1 x1		
02 \bar{x}	10 \bar{y}	2 a	2 x2		
03 sx	11 sy	3 b	3 x3		
04 σ_x	12 σ_y	4 c	4 y1		
05 xmin	13 ymin	5 r	5 y2		
06 xmax	14 ymax	6 r^2	6 y3		
07 $\sum x$	15 $\sum y$	7 R^2	7 Q1		
08 $\sum x^2$	16 $\sum y^2$	8 resid	8 Med		
			9 Q3		

PRGM (PRGM)

A EXEC		B EDIT		C NEW	
01		01		Cleave new program	
02		02		Press ENTER	
03		03			
04		04			
05		05			
06		06			

Menu tree 5

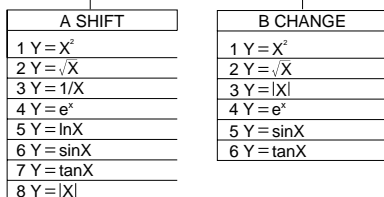
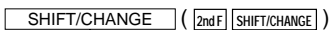
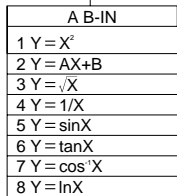
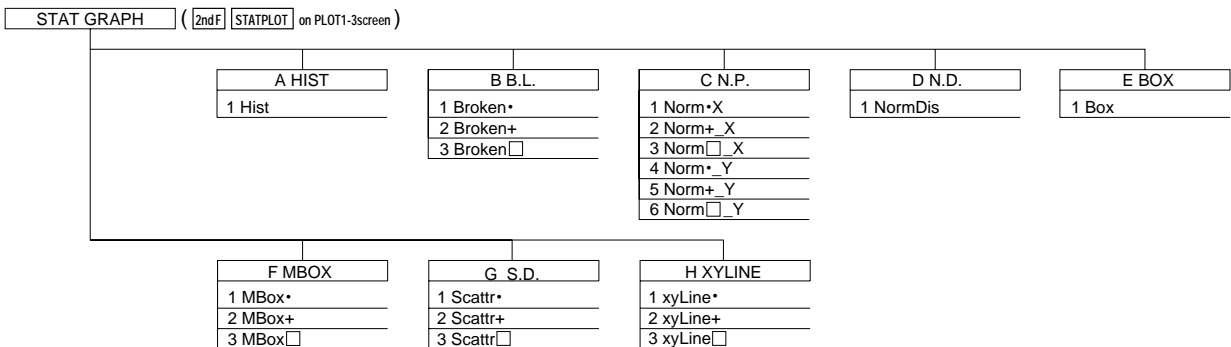
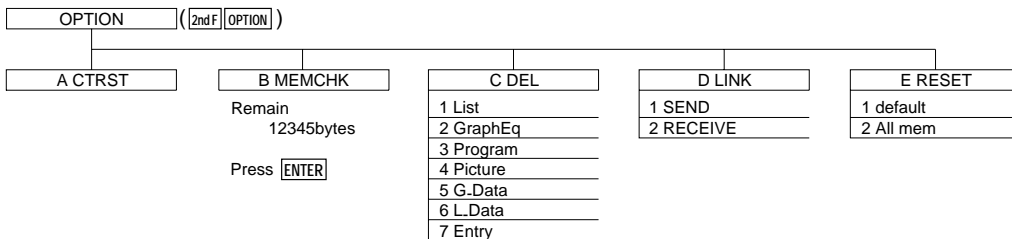

Menu tree 6

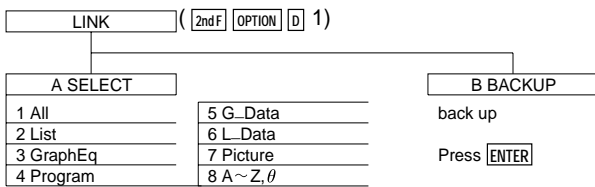
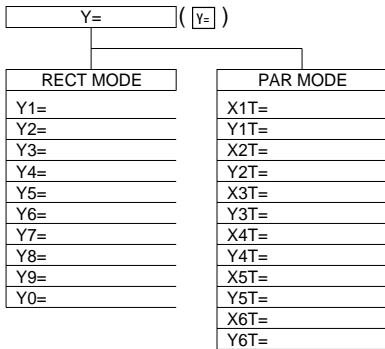

Specifications

Dimensions W x D x H (mm)		163 x 76 x 19.5 (without hardcase)	
Power		R03 (AAA) x 4	
Backup Battery		CR2032 x 1	
Display	Size (dot)	96 x 64	
	Line x Characters	8 x 16	
	Character Size (dot)	5 x 7	
	Digits (mantissa + exponent)	10 + 2	
Memory	Total Memory Size	32 KB	
	Constant Memory	27 + last answer memory	
Accessory	Protective hard case		
Standard Features	Graphing	Function graphing	Up to 10
		Parametric graphing	Up to 6
		Zoom, Trace	
		Table of function values	
	Statistics	Regression models	10
		Scatter Plots and Histograms	
		Box-and-Whisker Diagrams	
	Other	List	Up to 6 (Maximum length : 999)
		Programming	
		Trigonometry functions (including sec, csc, cot)	
		Fraction/Decimal conversions	
		Last entry recall	
		Last answer recall	
	Features unique to Sharp	Equation editor, Shift/Change, Slide show (Built-in), Rapid graph, Rapid window, Rapid zoom, List grouping	
Peripheral	CE-450L	Unit-to-unit communications cable	
	CE-LK1P	PC-Link (Print screen/Data storage)	
	EL-945T/94T	OHP system (includes controller)	

* Design and specifications are subject to change without notice.

* Some products may not be available in some countries.

SHARP

EL-9450/9400 Graphing Calculator

SHARP

SHARP CORPORATION OSAKA, JAPAN

Distributed by: